

JLS-LLE-WPPA102 SERIES BLUETOOTH CONTROLLER NODE

JAYKAL

PROJECT NAME:

JAYKAL LED SOLUTIONS, INC.

www.jaykal.net

PROJECT NOTES:

21499 Baltimore Ave.

Georgetown, DE 19947

(P) 302-295-0015

(F) 302-295-0016



PRODUCT DESCRIPTION

The JLS-LLE-WPPA102 is an advanced Bluetooth control node engineered for seamless integration with LumaLinx sensor ecosystems. Featuring an enhanced antenna design, it achieves a superior transmission range of up to 328 feet (100 meters), making it optimal for high-mounting applications and installations requiring extended inter-node distances. The IP66-rated enclosure ensures robust protection against dust and water ingress, while its white finish is specifically designed to aesthetically complement commercial indoor luminaires. Constructed from UV-rated polycarbonate material, the JLS-LLE-WPPA102 offers exceptional durability and resistance to environmental degradation, ensuring long-term performance in diverse lighting control applications.

FEATURES

- Simplified reset: Factory settings restored by 3-second magnet proximity
- Seamless connectivity: Enables wireless linking with other LumaLinx devices
- Environmental protection: IP66-rated for wet location applications
- Durable construction: UV-rated polycarbonate housing with white finish
- Extended range: Enhanced antenna design with Bluetooth transmission up to 328ft



Revised 11/13/24

Specifications are typical values and may change without notification

efficiency. illuminated.

JLS-LLE-WPPA102 SERIES BLUETOOTH CONTROLLER NODE

JAYKAL

SPECIFICATIONS TABLE

JLS-LLE-WPPA102 SERIES

INPUT VOLTAGE	12VDC
INPUT CURRENT	41mA Max
INPUT POWER	0.5W
OUTPUT CURRENT	10mA Max
OUTPUT POWER	0.1W
DIMMING	Class 2, 0-10V DC 10mA Max
SINKING CURRENT	10mA Max
BLUETOOTH TRANSMIT	100ft Max
RADIO FREQUENCY	2.4GHz ± 75MHz
BLUETOOTH VERSION	5.0
HOUSING MATERIAL	UL 94-5VA
INDOOR/OUTDOOR USE	Indoor Use
OPERATING TEMPERATURE	-30°C to 65°C, -22°F to 149°F
STORAGE TEMPERATURE	-30°C to 85°C, -22°F to 185°F
IP RATING	IP66/Wet Location
COLOR	White
WARRANTY	5 Years
COMPLIANCE	UL8750, UL1376, RoHS

Due to our continued efforts to improve our products, specifications are subject to change without notice.

Ordering Guide

MODEL	BASE	COLOR	BLUETOOTH VERSION	DESCRIPTION
JLS-LLE-WPPA102-BH4.B1	BH4	White	5.0	Bluetooth Controller Node
JLS-LLE-WPPA102-BH4.A0	BH4	White	4.2	
JLS-LLE-WPPA102-AUX.A0	AUX	White	4.2	
JLS-LLE-WPPA102-AUX.B1	AUX	White	5.0	
JLS-LLE-WPPA102-Z10.A0	Zhaga Z10	White	5.0	
JLS-LLE-WPPA102-Z10.B1	Zhaga Z10	White	5.0	

Specifications are typical values and may change without notification

efficiency. illuminated.

JLS-LLE-WPPA102 SERIES BLUETOOTH CONTROLLER NODE

JAYKAL

Accessory Ordering Guide

MODEL	TYPE	DESCRIPTION
JLS-LLE-SC01-AUX	Base	AUX Receptacle
JLS-LLE-BH4	Base	BH4 Receptacle
JLS-LLE-SC03-AUX	Accessory/Adapter	AUX Socket Extension Adapter

WIRING

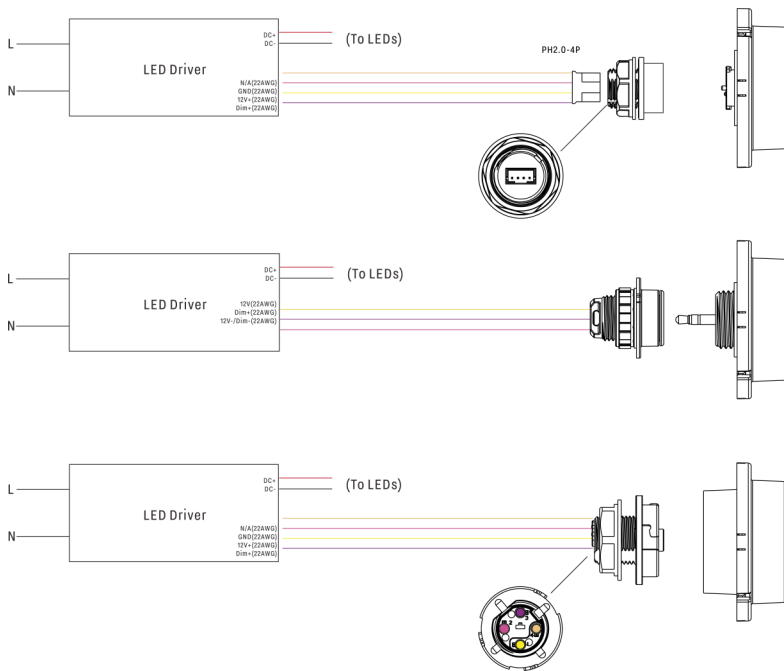

Socket Mounting Dimensions		
Size	T.P.I - inch	Major Dia. - inch
R1/2	14	0.825

DIMENSIONS

Unit:inch/mm

JLS-LLE-WPPA102-BH4-W

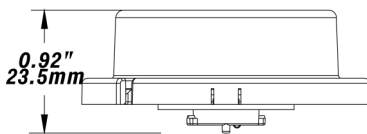

JLS-LLE-WPPA102-AUX-W

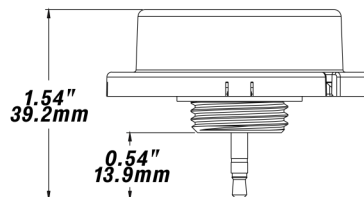

JLS-LLE-WPPA102-Z10-W

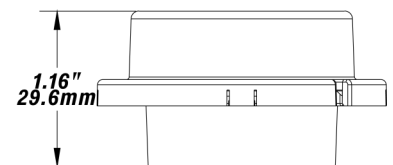

Specifications are typical values and may change without notification

efficiency. illuminated.

JLS-LLE-WPPA102 SERIES BLUETOOTH CONTROLLER NODE

JAYKAL

ACCESSORIES DIMENSIONS

JLS-LLE-WSC01-AUX

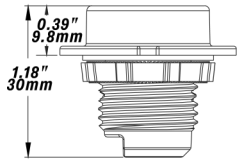

Zhaga Z10 (By Others)

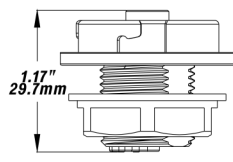

JLS-LLE-WSC03-AUX

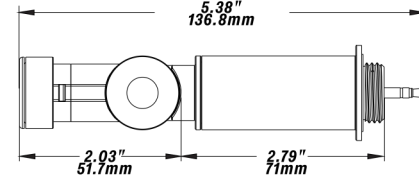

JLS-LLE-BH4W

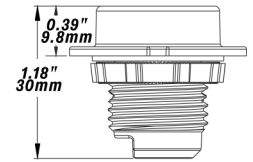

Socket Mounting Dimensions		½ inch US standard knockout
Size	T.P.I - inch	Major Dia. - inch
R1/2	14	0.825

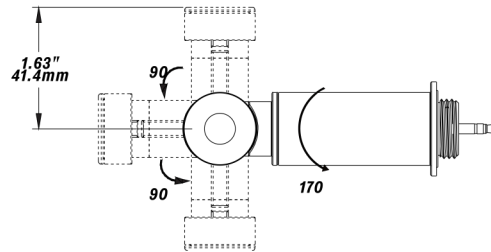

TRANSMISSION

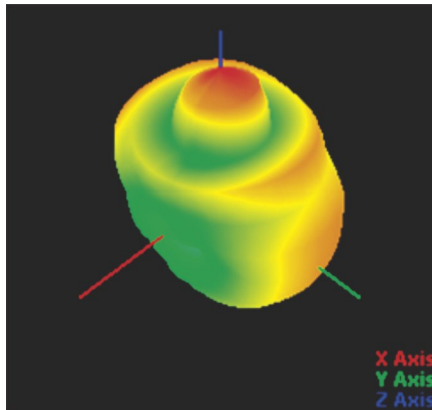

T45-P4 5T

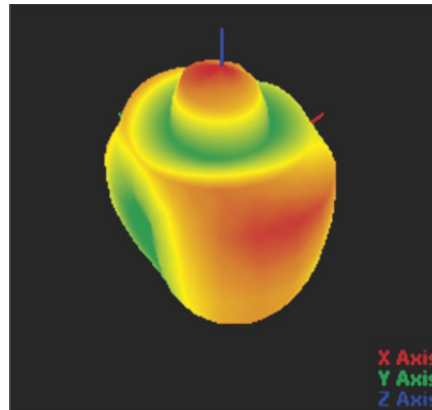

45-P22 5T

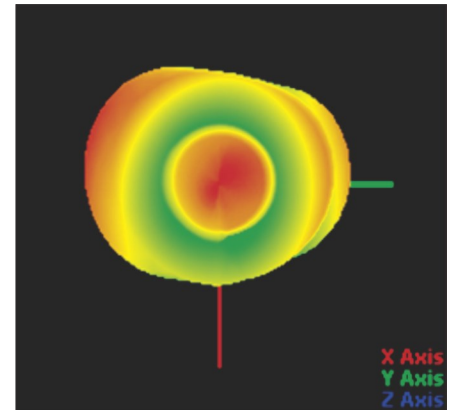

0-P0

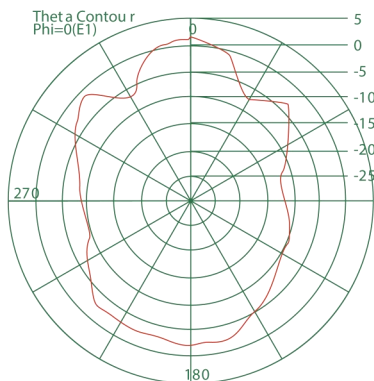

XOZ

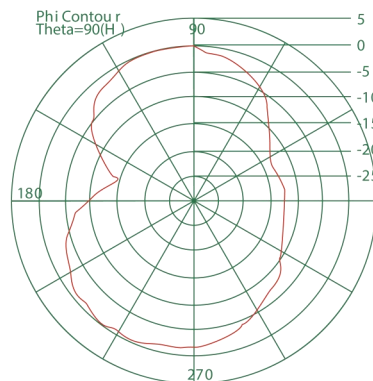

XOY

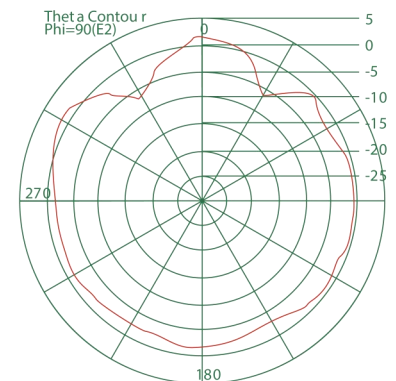

YOZ

Specifications are typical values and may change without notification

JLS-LLE-WPPA102 SERIES BLUETOOTH CONTROLLER NODE **JAYKAL**

TRANSMISSION

Wireless Signal Strength	
Transmission Distance	RSSI(dbm)
82ft(25m)	-76
164ft(50m)	-79
246ft(75m)	-87
328ft(100m)	-90

Note: The test transmission distance of two JLS-LLE-WPPA102-W

PRODUCT LABEL

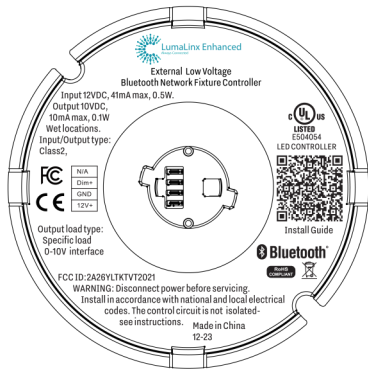

JLS-LLE-WPPA102-BH4.B1



JLS-LLE-WPPA102-AUX.B1

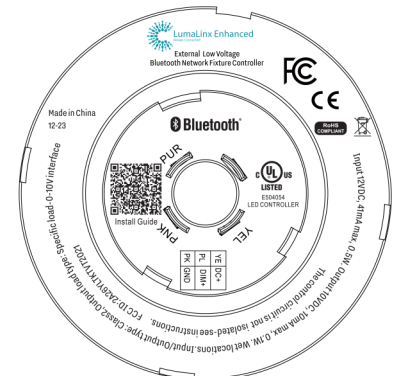

JLS-LLE-WPPA102-Z10.B1

The Bluetooth word mark and logos are registered trademarks owned by Bluetooth SIG, Inc. and any use of such marks by LumaLinX is under license. Other trademarks and trade names are those of their respective owners.

APP DOWNLOAD



Specifications are typical values and may change without notification

efficiency. illuminated.