

# LED Wall Pack Installation Instruction

## IMPORTANT SAFEGUARDS

When using electrical equipment, basic safety precautions should always be followed including the following:

## READ AND FOLLOW ALL SAFETY INSTRUCTIONS

- 1.To reduce the risk of electrical shock, turn off the power supply before installation or servicing.
- 2.This luminaire must be installed in accordance with the NEC or your requirements, consult a qualified electrician.
- 3.If NEMA photo control is installed refer to NEMA receptacle section For instructions.
- 4.Verify the availability of necessary tools and incidental material.
- 5.The fixture is not allowed to disassemble the structure or components.

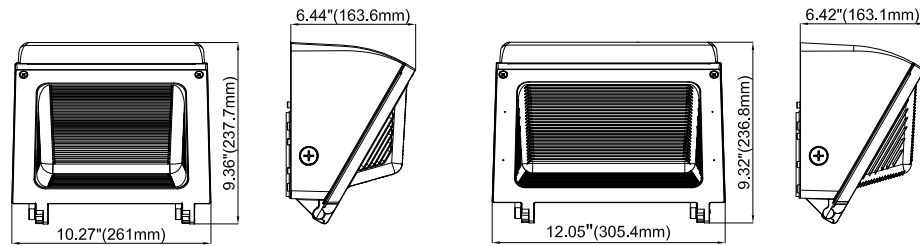

80W

120W

## TO INSTALL

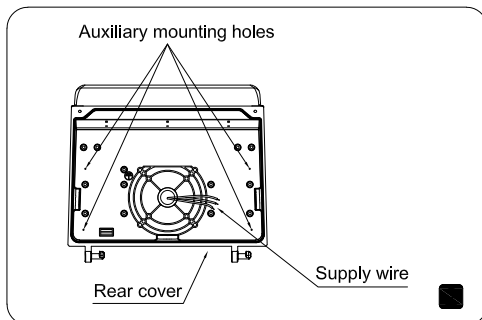
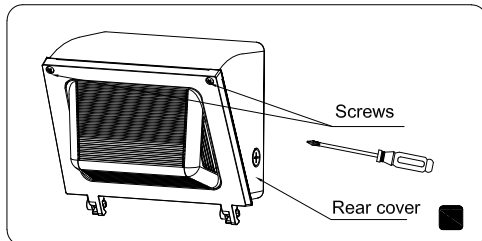

## LUMINAIRE INSTALLATION

### STEP 1(Figure 1):

Remove two screws, remove the rear cover of the luminaire and pull the connector.

### STEP 2-1(Onto a recessed 4" rectangular/octagonal J-Box) (Figure 2):

- 1.Verify that supply power is off and that the J-Box is securely mounted within the structural surface.
- 2.Remove both J-Box fasteners from j-box (set aside for re-installation as needed)
- 3.Drill holes as J-Box required on the rear cover.
- 4.Position rear cover over J-Box feeding supply wires through the center of the Rear cover and slit in gasket. Replace fasteners from step 2 (do not fully tighten).
- 5.Using a contractor level, ensure Rear cover is level and fully tighten fasteners (Use washers as required to ensure a secure fit).

## TO INSTALL

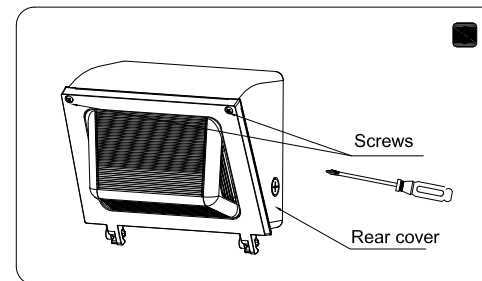
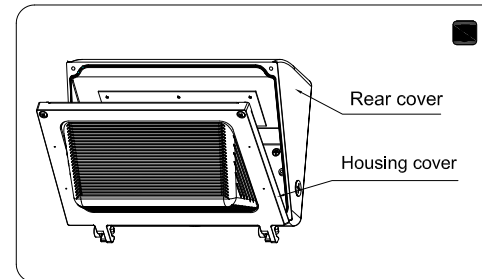
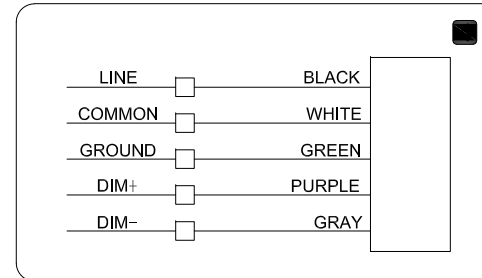
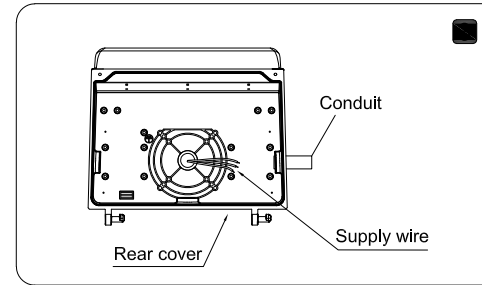

## LUMINAIRE INSTALLATION

### STEP 2-2(Conduit-stub up) (Figure 3):

- 1.Drill holes on the rear cover as auxiliary mounting holes.
- 2.Verify that supply power is off. Using a contractor level, ensure rear cover is level and mark mounting surface thru selected auxiliary mounting holes.
- 3.Drill holes as marked in step 1 and install appropriate mounting inserts capable of handling fixture load requirements.
- 4.Feed supply wires through the center of the rear cover and slit in gasket.
- 5.Ensure rear cover is level. Fully tighten fasteners (use washers as required to ensure a secure fit).

### STEP 2-3(Conduit-surface) (Figure 3):

- 1.Drill holes on the rear cover as auxiliary mounting holes.
- 2.Verify that supply power is off. Using a contractor level, ensure rear cover is level and mark mounting surface through selected auxiliary mounting holes.
- 3.Drill holes as marked in step 1 and install appropriate mounting inserts capable of handling fixture load requirements.
- 4.Ensure rear cover is level. Fully tighten fasteners (use washers as required to ensure a secure fit).
- 5.Attach 1/2"NPT conduit fittings using the appropriate EMT rain tight compression connections(not provided) onto the factory machined conduit entry opening.

### STEP 3(Figure 4):

Make supply wire (power and dimming) to fixture wire connections as required through splice access. The voltage driver permits. Operation at 120V-277V, 120V-347V, 200V-480V, 50 or 60 Hz. 0-10V control wires must be rated for 300V minimum, for 0-10V Dimming. Follow the wiring directions as shown in figure below.

### STEP 4(Figure 5):

Fixture slightly upward, align fixture housing indicators with rear cover hooks and slip fixture back onto hooks and insert the connector.

### STEP 5(Figure 6):

Close the housing indicators to the rear cover and fully tighten fasteners. The bottom shell is sprayed with glue and tightly sealed to the wall.

Trouble shooting: If this fixture fails to operate properly,check to make sure: The fixture is wired correctly. The fixture is grounded correctly. The line voltage at the fixture is correct.If all these variables have been checked and the fixture still does not operate as specified,contact your local distributor.