

Architectural Ceiling Light - C18 - F216



JAYKAL

PROJECT NAME:

JAYKAL LED SOLUTIONS, INC.

www.jaykal.net

PROJECT NOTES:

26832 Lewes Georgetown Hwy,
Building 2, Unit E
Harbeson, DE 19951
(P) 302-295-0015
(F) 302-295-0016

DESCRIPTION:

This LED Surface Mounted Luminaire is elegantly designed to compliment new or existing buildings, while delivering the dramatic energy savings of LED technology. This fixture is an ideal replacement for existing incandescent or CFL fixtures in hotels and apartment complexes.

FEATURES & BENEFITS:

- ◆ Wattage Option: 18W
- ◆ CCT: 3000K / 4000K / 5000K
- ◆ Frosted Glass
- ◆ Replaces up to 75W HID, 80W incandescent or up to 36W CFL
- ◆ 5 Year Warranty
- ◆ Finish: Brushed Nickel Standard, Bronze Available
- ◆ Near Zero Maintenance
- ◆ Uses up to 80% less energy



5 YEAR STANDARD WARRANTY—EXTENDED WARRANTIES AVAILABLE

(P) 302-295-0015 | (E) sales@jaykal.net | (W) www.jaykal.net

Specifications are typical values and may change without notification

efficiency. illuminated.

Architectural Ceiling Light - C18 - F216



JAYKAL

SPECIFICATIONS TABLE

Watt	18W	Lumens	1440 lm	Efficacy	80 lm/w
Input Voltage	100-120VAC 50/60hz	Power Factor	0.93	CRI	> 80
THD	< 15 %	CCT	3000K / 4000K / 5000K		
Life (L70)	50,000+ hours	Illumination Angle	120°	Operational Temperatures	-30°C — 60°C
Housing Finish	Brushed Nickel	Lens Finish	Frosted White	Protection	IP44
Housing Material	Sheet Metal	Lens Material	Glass	Environment	Indoor and Damp locations
Weight	2.86 lbs. / 1.3 kg	Dimensions	16.1 X 4.5 in / 410 X 115 mm		
UL File No	E360683	Warranty	5 Years		

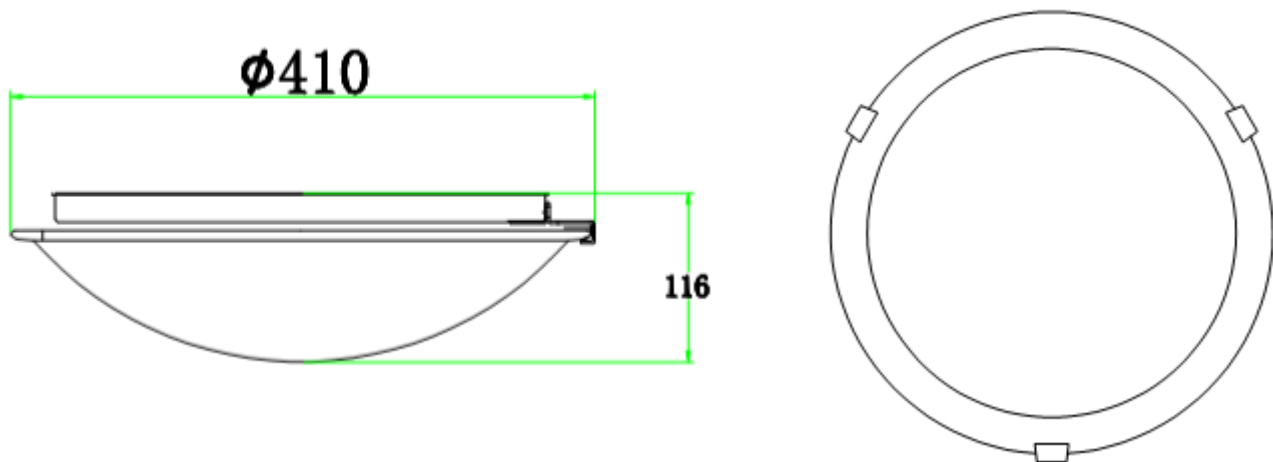

ORDERING GUIDE

MODEL NUMBER	- FINISH	- CCT
JLS68102-C18-F216	N = Brushed Nickel B = Bronze	30K = 3000K 35K = 3500K 40K = 4000K 50K = 5000K

(P) 302-295-0015 | (E) sales@jaykal.net | (W) www.jaykal.net

Specifications are typical values and may change without notification

efficiency. illuminated.